

PROMINENCE MARKING IN KAZAN TATAR DECLARATIVES

Adam J. Royer; Sun-Ah Jun

Department of Linguistics, University of California Los Angeles, Los Angeles, USA
ajroyer@ucla.edu; jun@humnet.ucla.edu

ABSTRACT

This study reports on prominence marking in Kazan Tatar, a Turkic language spoken in Russia, in the framework of Autosegmental-Metrical phonology. The data are narrow and broad focus declaratives collected from eight native Tatar speakers.

Analysis of broad focus declaratives confirmed the intonation model proposed earlier, i.e., stressed syllables (which is word-final) of sentence-medial words are marked by rising pitch accents, [L+H*] or [H*], while verbs are optionally marked with a high tone, [Hi], on their initial syllable. In narrow focus, focused words were produced with [L+H*], [Hi], or [Hi L+H*], with expanded pitch range. This suggests that the [Hi], which is not a pitch accent, marks prominence at the left edge of a word/phrase, similar to French initial accent. Words before and after the focused word were often deaccented or realized with a compressed pitch range. Furthermore, an IP-final [L%] truncation was observed when a sentence final verb was focused, ending with [L+H*] on the verb's final syllable. But, the [L%] was fully realized when the IP-final syllable is extra-lengthened, creating a LHL contour.

Keywords: intonation, Turkic, Tatar, prominence, focus, Autosegmental-Metrical, initial accent

1. INTRODUCTION

Tatar is a Turkic language spoken by approximately 5 million speakers in Tatarstan, Russia. It shares many similarities with other Turkic languages, such as SOV word order and a rich, agglutinative morphology. Additionally, Comrie [2] notes that like other Turkic languages, stress in Tatar typically falls on the last syllable of a morphological word, with some exceptions (e.g., loan words from Russian, question words).

Previous work on Tatar intonation [12, 13], analyzed in the framework of Autosegmental-Metrical (AM) Phonology [10, 1, 8], suggests that some of the characteristics of Tatar's intonation are similar to those of Turkish [7, 3, 4]. In both languages, a prominent word is typically marked by a pitch accent, realized on the stressed syllable of the word, and there are two prosodic units above the word, i.e., the Intonational Phrase (IP) and the

Intermediate Phrase (ip). However, Tatar was suggested to differ from Turkish in the way pitch accents are realized in an IP. In Turkish, the f₀ peaks of H* pitch accents do not show downtrend throughout the phrase, produced in broad focus. Instead, the f₀ peak of the pre-nuclear accent immediately before the nuclear accent is higher than that of the preceding pre-nuclear accent. Furthermore, the f₀ peak of the nuclear accent, which is typically on the pre-verbal argument, is substantially lower (!H*) than that of the preceding accent. This distinction was maintained when a word received a nuclear accent by being narrowly focused. But, in Tatar, the f₀ peaks of L+H* pitch accents show downtrend throughout the phrase, produced in broad focus. It is not clear if there is any phonetic or phonological difference between the nuclear accent and pre-nuclear accents. Since earlier work on Tatar intonation was only based on broad focus declarative utterances, this leaves open the question of how prominence is marked in narrow focus utterances and if it differs from prominence marking in broad focus utterances. Below, we are introducing the model of Tatar intonational phonology proposed in [13], which is adopted in the present study. The model is based on declarative utterances produced in broad focus.

1.1. Tatar Intonational Model

As mentioned above, in declarative, broad focus utterances in Tatar, the stressed syllable of a prominent word receives a pitch accent and there are two prosodic units larger than a word that are marked by intonation: the IP and the ip. Figure 1 shows a tree diagram illustrating the prosodic hierarchy of Tatar and its tonal affiliations in the model. The head (i.e., stressed syllable) of a prominent word is typically marked with a [L+H*] post-lexical pitch accent but may also carry a [H*] or a [L*] depending on its context.

Tatar has another tonal marking which is optionally realized within the first two (though more often on the first) syllables of a word. This optional tone is called the [Hi], indicating that it is a high tone that appears on the 'initial' syllable of a word. This tone is not categorized as a pitch accent because it surfaces on an unstressed, non-final syllable of a word. However, since the [Hi] syllable is slightly louder than adjacent syllables, this tone

was proposed to be a prominence-marking tone. This is similar to the optional Hi tone in French intonation proposed in [6] or the word-initial tone traditionally known as ‘initial stress’ [9, 11] or ‘emphatic accent’ [11].

[13] reports that the location of the [Hi] tone was limited. It occurred after the last pitch accented word in the same ip (i.e., on the initial syllable of an ip-final word), or ip-initially where no pitch accent is present (i.e., on the initial syllable of the ip-initial word). This means Hi can be the only tone of a word or an ip, making the Hi-toned word moderately prominent. In both cases, the right edge of an ip is marked by a L boundary tone (i.e., L-; or L% when the ip is IP-final).

Figure 1: Prosodic hierarchy and tonal affiliations for Tatar, proposed in [3]

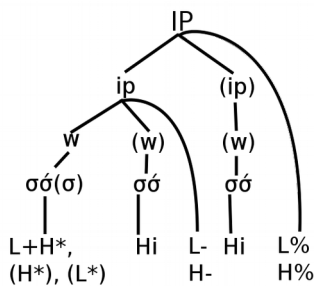

2. PRESENT STUDY

The purpose of the present study is to examine how prominence is marked in narrow focus declarative utterances in Tatar. Furthermore, of interest is the nature of the [Hi] in prominence marking. As it is reported to serve a prominence marking function, it seems possible that a higher prevalence of [Hi]s would be encountered in the marking of narrowly focused words.

2.1. Methodology

Data were collected from six native Tatar speakers (3 females) living in Tatarstan, Russia. In addition to eliciting sentences with narrow focus (by using the wh-question/answer format or the yes/no-question format to trigger corrective focus), the broad focus versions of the same utterances were also elicited prior to the narrow focus version so that they could serve as comparisons. All of these utterances contained only 3 words, in the order of SOV (the subject, the object, and the verb). Utterances varied in whether the subject, object, or verb was narrowly focused. Each focused word also varied in length from 1 to 4 syllables. Pitch tracks of a total of 203

broad and narrow focus sentences from all 6 speakers were examined and analyzed in *Praat*.

In addition to the data collected in Tatarstan, data from two female native speakers of Tatar living in Los Angeles were also collected. While some of the utterances were of the same SOV form as the Tatarstan data, the Los Angeles data varied in the number of words in a sentence because of the addition of nominal modifiers in some cases or greater syntactic complexity in others. A total of 147 sentences were examined for both speakers.

3. RESULTS

3.1. Pitch accenting and prominence marking

Broad focus declarative utterances from the two datasets exhibited similar accenting and boundary marking patterns as those reported in [3]. The [L+H*] was the most common pitch accent, followed by the [H*], for subjects and objects. The verb was *optionally* marked with an [Hi] on its first (or second, if applicable) syllable, but was rarely pitch accented. Figure 2 shows an example pitch track illustrating the verb without any prominence tone, while Figure 3 shows an example pitch track where the initial syllable of the verb receives an Hi tone, followed by a L% boundary tone on the verb-final syllable.

Figure 2: Broad focus declarative sentence showing L+H* pitch accent on the subject and the object, but no Hi or pitch accent on the verb.

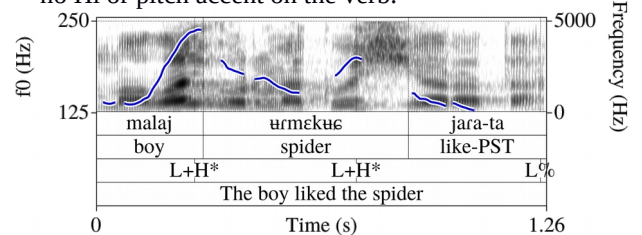
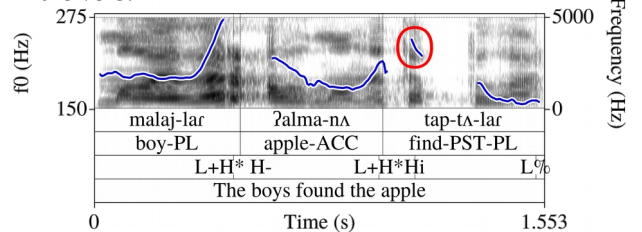

Figure 3: Broad focus declarative sentence, showing L+H* on the subject and the object, and a Hi tone on the verb.



As for the narrow focus utterances, a wider diversity was found in marking prominence. When a word was narrowly focused, one of the three options was used. The first option was to carry a [L+H*] pitch accent on the stressed syllable of the focused word, with expanded pitch range. This means that

even the verb, when focused, carried this type of pitch accent to mark its prominence. The second option was to carry an [Hi] tone on the initial syllable of the word, with expanded pitch range and increased amplitude, but without carrying any pitch accent. This pattern was found in polysyllabic words. While this tonal pattern is attested on the verb in the broad focus condition, it was found on the focused subjects and objects as well. The third option was a combination of the two tones in a single word, i.e., an [Hi] on the initial syllable and a [L+H*] on the stressed syllable (see Figure 4). Speakers used the first option ([L+H*]/[H*]) on the focused word) 39% of the time, the second option ([Hi]) 31% of the time, and the third option ([Hi L+H*]) 25% of the time. The remaining 5% could not be categorized because of errors in the location of focus.

Figure 4: Narrow focus on the subject “Leila”, by using both [Hi] and [L+H*] tones.

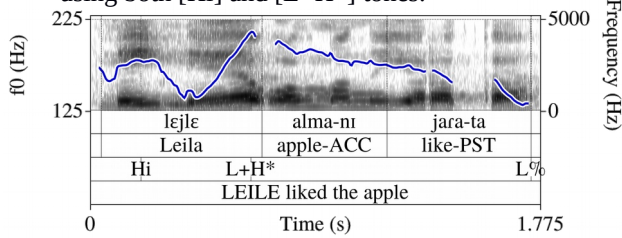

3.2. Boundary marking

Narrowly focused words were sometimes preceded or followed by an ip or IP juncture. This was most common with subject-focus utterances, in which a strong juncture would follow the subject. By putting the focused word in its own ip or IP, the prominence of the focused word is further highlighted (see Figure 5).

Figure 5: Narrow focus on the subject, “Mariam”, showing a [L%] and a pause after the subject.

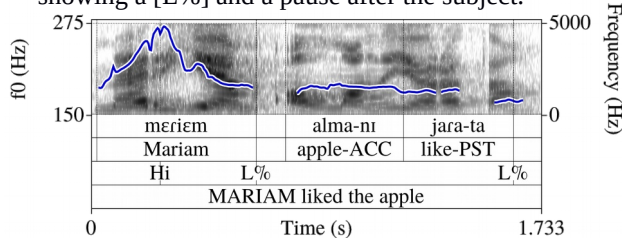

The tonal marking of this juncture varied across speakers. After the focused subject, either a [H] or a [L] boundary tone was used. But when the focus was marked by a L+H* pitch accent, followed by a H boundary tone, the most salient cue to the big juncture after the focused word was lengthening of the ip/IP-final syllable. However, when a [L] boundary tone was used to mark the juncture, the peak of

the [L+H*] was realized early in the stressed syllable (see Figure 6).

Figure 6: Narrow focus on the subject “boy”, showing an f0 fall to a [L-] following a [L+H*] on the same syllable.

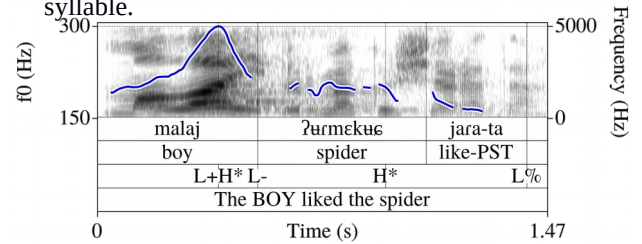

3.3. Deaccenting and pitch range compression

Across all speakers, words following focused subjects and objects tended to be deaccented and/or compressed in their pitch range, maintaining a minor f0 peak from a pitch accent. See Figure 5, for an example of a deaccented post-focus string.

In pre-focal position, however, speakers varied in their realization of accents. One speaker in particular strongly reduced the prominence of the pre-focal words by completely deaccenting and/or drastically compressing the pitch range on those words, thereby realizing them with an f0 plateau. Figure 7 shows an example where the pre-focus string is compressed in pitch range (It is also separated from the focused word by a large break).

Figure 7: Narrow focus on the verb, showing deaccenting and pitch compression of the pre-focal subject and object.

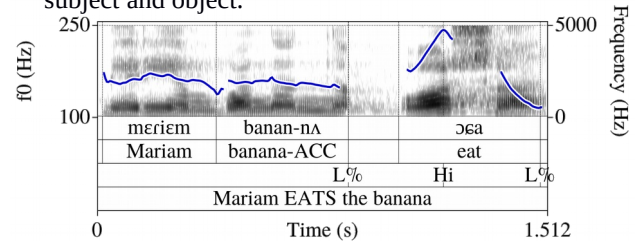

3.4. Truncation of [L%]

As mentioned previously, focused verbs tend to carry a pitch accent on their final, stressed syllable, followed by a [L%] boundary tone to signal that the utterance is a declarative. In this case, the IP-final syllable is extra-lengthened to accommodate all the 3 tones, [LHL], i.e., a [L+H*] pitch accent and a [L%] boundary tone. An example of this IP-final extra-lengthening and [L%] realization is seen in Figure 8. However, in certain cases, the f0 at the end of the IP ends high, at the level of the [L+H*], indicating a truncated [L%]. An example of [L%] truncation is seen in Figure 9. (Figure 8 also shows that [Hi] can occur before a [H%] boundary tone.)

Figure 8: Narrow focus on the verb, in declaratives, showing extra-lengthening of the IP-final syllable to host a [L+H* L%] tune.

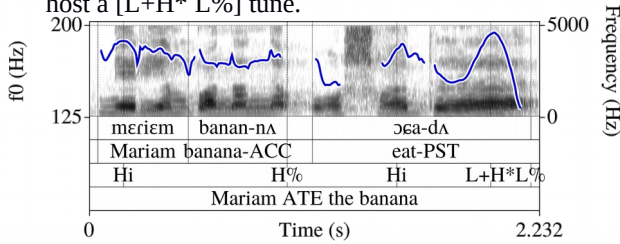
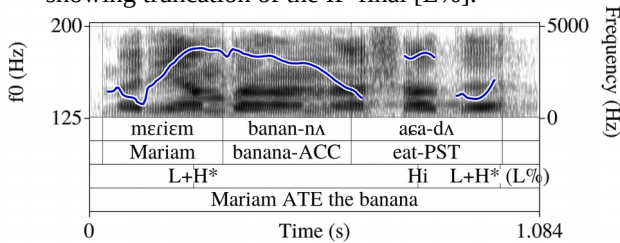

Figure 9: Narrow focus on the verb, in declaratives, showing truncation of the IP-final [L%].



4. DISCUSSION AND CONCLUSIONS

With regard to prominence marking in broad focus declarative utterances, our data largely corroborate the findings of [13]. Subjects and objects were typically accented with a [L+H*] on their respective stressed syllables, and verbs were not accented but sometimes carried a prominence marking [Hi] on their first or second syllable.

The strategies for marking narrow focus varied in terms of both head and edge marking. Three typical tunes emerged as options for narrow focus; [L+H*], [Hi], or [Hi L+H*] on the focused constituent. Additionally, focused constituents were optionally phrased into their own ip or IP by the use of a large juncture before or after it. Deaccenting of pre- and post-focus words, even across an ip or IP boundary, as well as pitch compression on these words, lent a strong salience to the focused word. This did the job of strengthening the prominence of the narrowly focused word by weakening the prominence of its surrounding words.

Further evidence for the [Hi] highlighting its host word was found in the narrow focus utterances. The [Hi] was often employed in focused constituents either in conjunction with a [L+H*] on its host word or by itself. Whereas the distribution of the [Hi] was relatively restricted in previous accounts (i.e. always following a [L+H*] before [L-], or in an IP-final ip by itself preceding a [L%]), the data shown here extend its domain to include cases in which it is followed by a [L+H*] in the same word (see Figures 4, 8, and 9), cases in which it is the sole tonal marking of focus in its own IP (see Figure 5 and 7),

and a sole tonal marking of a non-focus IP, preceding a [H%] (see Figure 8).

Figure 10: Prosodic hierarchy and tonal affiliations for Tatar intonational phonology: A revision from [3]. (All tones are optional except for ip and IP boundary tones.)

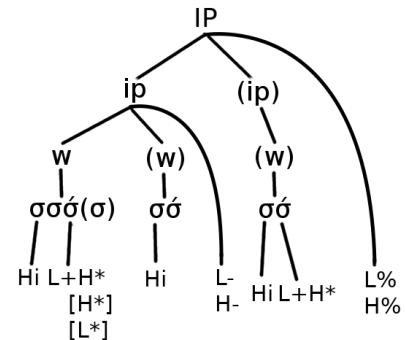

Based on the findings from the current study, especially on the distribution of the Hi tone, a revision to the previous model of Tatar intonational phonology [13] is proposed in Figure 10. It is important to note that all of the prominence marking tones (i.e. the pitch accents and [Hi]) are optional, whereas the boundary marking tones (i.e. ip and IP [L] and [H] tones) are not.

The frequent use of the [Hi] tone in focused constituents provides further evidence for its prominence marking function despite the fact that it is not a pitch accent and appears at the beginning of a word or a phrase, thus marking the edge of a prosodic unit. As mentioned in Section 1.1, this is very similar to the ‘initial stress’ or the [Hi] tone of French intonation [6]. The French [Hi] is also not a pitch accent and its location is limited to the beginning two syllables of a content word within an Accentual Phrase (AP). Furthermore, its presence is optional due to various factors including rhythm, emphasis, length of a word/phrase, and its location in a phrase. In non-IP-final positions, [Hi] is generally followed by a pitch accent (or primary accent) in the same AP, but is often the only tone of the IP-final AP. Further study is needed to find out what factors affect the distribution of Tatar [Hi] tone.

When taking into account the typology of intonational phonology and the AM model, Tatar stands out for two reasons. Firstly, though Tatar is a head prominence language [5], it is possible to have an IP or ip with no head, i.e., [Hi] is the only tone of an ip or IP. Secondly, a string of words before a focused word can also be deaccented, even across an IP boundary. These two phenomena in particular warrant further investigation of Tatar to expand on what is thought to be possible in the intonational phonology of languages.

5. REFERENCES

- [1] Beckman, M. & Pierrehumbert, J. (1986). Intonational structure in Japanese and English. *Phonology Yearbook* 3: 255-309.
- [2] Comrie, B. Tatar (Volga Tatar, Kazan Tatar) phonology. *Phonologies of Asia and Africa*, 2, pp. 899-911. Chicago, 1997.
- [3] Ipek, C. (2015) *The Phonology and Phonetics of Turkish intonation*. USC. Dissertation.
- [4] Ipek, C. & Jun, S.-A. (2013) Towards a Model of Intonational Phonology of Turkish: Neutral Intonation. In the *Proceedings of Meeting on Acoustics (POMA)*, vol. 9, pp.060230-069238.
- [5] Jun, S.-A. (2014) Prosodic Typology: By Prominence Type, Word Prosody, and Macro-rhythm. In Sun-Ah Jun (ed.) *Prosodic Typology II: The Phonology of Intonation and Phrasing*. pp. 520-539. Oxford University Press.
- [6] Jun, S.-A. and Fougeron, C. (2000) A Phonological Model of French Intonation. In Antonis Botinis (ed.) *Intonation: Analysis, Modeling and Technology*, Kluwer Academic Publishers. pp.209-242.
- [7] Kan, S. (2009) *Prosodic Domains and the syntax-prosody mapping in Turkish*. MA thesis. Boğaziçi University.
- [8] Ladd, B. (1996/2008) *Intonational Phonology*. Cambridge University Press.
- [9] Padeloup, V. (1990) *Modèle de règles rythmiques du français appliquées à la synthèse de la parole*. Dissertation. Université d'Aix-en-Provence.
- [10] Pierrehumbert, J. (1980) *The Phonology and Phonetics of English Intonation*. MIT dissertation.
- [11] Rossi, M. (1985) L'intonation et l'organisation de l'énoncé. *Phonetica* 42, 135-153.
- [12] Royer, A. J. (2017). Towards a model of Tatar intonational phonology. *The Journal of the Acoustical Society of America*, 142(4), 2519-2519.
- [13] Royer, A., & Jun, S.-A. (2018). A Preliminary Model of Tatar Intonational Phonology. In *Proc. 9th International Conference on Speech Prosody 2018* (pp. 769-773).